

Compact Disc Player **C-701A**

Instruction Manual

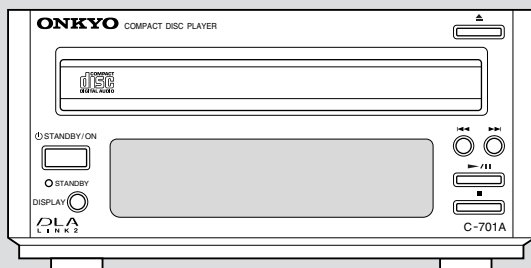

COMPACT
disc
DIGITAL AUDIO

Before using**Connections****Operations****Other Information**

Before using

Thank you for purchasing ...

Thank you for purchasing Onkyo C-701A CD player.

Please read this manual thoroughly before making connections and plugging in the unit.

Following the instructions in this manual will enable you to obtain optimum performance and listening enjoyment from your new C-701A.

Please retain this manual for future reference.

Main Features

- A compact, discrete component with 155mm (6-1/8") wide
- Dual-Channel Optical Digital Outputs
- Linear Single-bit D/A Converter

WARNING:

TO REDUCE THE RISK OF FIRE OR ELECTRIC SHOCK, DO NOT EXPOSE THIS APPLIANCE TO RAIN OR MOISTURE.

CAUTION:

TO REDUCE THE RISK OF ELECTRIC SHOCK, DO NOT REMOVE COVER (OR BACK). NO USER-SERVICEABLE PARTS INSIDE. REFER SERVICING TO QUALIFIED SERVICE PERSONNEL.



The lightning flash with arrowhead symbol, within an equilateral triangle, is intended to alert the user to the presence of uninsulated "dangerous voltage" within the product's enclosure that may be of sufficient magnitude to constitute a risk of electric shock to persons.



The exclamation point within an equilateral triangle is intended to alert the user to the presence of important operating and maintenance (servicing) instructions in the literature accompanying the appliance.

This unit contains a semiconductor laser system and is classified as a "CLASS 1 LASER PRODUCT". So, to use this model properly, read this Instruction Manual carefully. In case of any trouble, please contact the store where you purchased the unit. To prevent being exposed to the laser beam, do not try to open the enclosure.

DANGER:

INVISIBLE LASER RADIATION WHEN OPEN AND INTERLOCK FAILED OR DEFEATED. AVOID DIRECT EXPOSURE TO BEAM.

CAUTION:

THIS PRODUCT UTILIZES A LASER. USE OF CONTROLS OR ADJUSTMENTS OR PERFORMANCE OF PROCEDURES OTHER THAN THOSE SPECIFIED HEREIN MAY RESULT IN HAZARDOUS RADIATION EXPOSURE.

**"CLASS 1 LASER
PRODUCT"**

This label on the right hand panel states that:

1. This unit is a CLASS 1 LASER PRODUCT and employs a laser inside the cabinet.
2. To prevent the laser from being exposed, do not remove the cover. Refer servicing to qualified personnel.

Important Safeguards

1. **Read Instructions** – All the safety and operating instructions should be read before the appliance is operated.
2. **Retain Instructions** – The safety and operating instructions should be retained for future reference.
3. **Heed Warnings** – All warnings on the appliance and in the operating instructions should be adhered to.
4. **Follow Instructions** – All operating and use instructions should be followed.
5. **Water and Moisture** – The appliance should not be used near water – for example, near a bathtub, washbowl, kitchen sink, laundry tub, in a wet basement, or near a swimming pool, and the like.
6. **Carts and Stands** – The appliance should be used only with a cart or stand that is recommended by the manufacturer.
- 6A. An appliance and cart combination should be moved with care. Quick stops, excessive force, and uneven surfaces may cause the appliance and cart combination to overturn.
7. **Wall or Ceiling Mounting** – The appliance should be mounted to a wall or ceiling only as recommended by the manufacturer.
8. **Ventilation** – The appliance should be situated so that its location or position does not interfere with its proper ventilation. For example, the appliance should not be situated on a bed, sofa, rug, or similar surface that may block the ventilation openings; or if placed in a built-in installation, such as a bookcase or cabinet that may impede the flow of air through the ventilation openings, there should be free space of at least 5 cm (2 in.) and an opening behind the appliance.
9. **Heat** – The appliance should be situated away from heat sources such as radiators, heat registers, stoves, or other appliances (including amplifiers) that produce heat.
10. **Power Sources** – The appliance should be connected to a power supply only of the type described in the operating instructions or as marked on the appliance.
11. **Polarization** – If the appliance is provided with a polarized plug having one blade wider than the other, please read the following information: The polarization of the plug is a safety feature. The polarized plug will only fit the outlet one way. If the plug does not fit fully into the outlet, try reversing it. If there is still trouble, the user should seek the services of a qualified electrician. Under no circumstances should the user attempt to defeat the polarization of the plug.
12. **Power-Cord Protection** – Power-supply cords should be routed so that they are not likely to be walked on or pinched by items placed upon or against them, especially near plugs, convenience receptacles, and the point where they exit from the appliance.
13. **Cleaning** – The appliance should be cleaned only as recommended by the manufacturer.
14. **Nonuse Periods** – The power cord of the appliance should be unplugged from the outlet when left unused for a long period of time.
15. **Object and Liquid Entry** – Care should be taken so that objects do not fall and liquids are not spilled into the enclosure through openings.
16. **Damage Requiring Service** – The appliance should be serviced by qualified service personnel when:
 - A. The power-supply cord or the plug has been damaged; or
 - B. Objects have fallen, or liquid has been spilled into the appliance; or
 - C. The appliance has been exposed to rain; or
 - D. The appliance does not appear to operate normally or exhibits a marked change in performance; or
 - E. The appliance has been dropped, or the enclosure damaged.
17. **Servicing** – The user should not attempt to service the appliance beyond that described in the operating instructions. All other servicing should be referred to qualified service personnel.

PORTABLE CART WARNING



Precautions

1. Power

WARNING

BEFORE PLUGGING IN THE UNIT FOR THE FIRST TIME, READ THE FOLLOWING SECTION CAREFULLY.

The voltage of the available power supply differs according to country or region. Be sure that the power supply voltage of the area where this unit will be used meets the required voltage (e.g., AC 230 V, 50 Hz or AC 120 V, 60 Hz) written on the rear panel.

Setting the STANDBY button to standby does not shut off the power completely. So the power cord should be removed from the AC outlet when the unit is not used for a prolonged time.

2. Do not touch this unit with wet hands

Do not handle this unit or power cord when your hands are wet or damp. If water or any other liquid enters the case, take this unit to an authorized service center for inspection.

3. Location of this unit

Place this unit in a well-ventilated location.

Take special care to provide plenty of ventilation on all sides of this unit especially when it is placed in an audio rack. If ventilation is blocked, this unit may overheat and malfunction.

Do not expose this unit to direct sunlight or heating units as this unit's internal temperature may rise and shorten the life of the pickup.

Avoid damp and dusty places and places directly affected by vibrations from the speakers. In particular, avoid placing the unit on or above one of the speakers.

Be sure this unit is placed in a horizontal position. Never place it on its side or on a slanted surface as it may malfunction.

Do not place near tuners or TV sets.

If placed next to a TV or tuner, it may cause reception interference resulting in some noise in the TV or tuner output.

4. Care

From time to time you should wipe the front and rear panels and the cabinet with a soft cloth. For heavier dirt, dampen a soft cloth in a weak solution of mild detergent and water, wring it out dry, and wipe off the dirt. Following this, dry immediately with a clean cloth.

Do not use rough material, thinners, alcohol or other chemical solvents or cloths since these could damage the finish or remove the panel lettering.

5. Points to remember

If this unit is brought from a cold environment to a warm one or is in a cold room that is quickly heated, condensation may form on the pickup, preventing proper operation. In this case, remove the disc and leave the power ON for about one hour to remove the condensation.

When transporting this unit, be careful not to bump it.

For U.S. model

The laser is covered by a housing which prevents exposure during operation or maintenance. However, this product is classified as a Laser Product by CDRH (Center for Devices and Radiological Health) which is a department of the Food and Drug Administration. According to their regulations 21 CFR section 1002.30, all manufacturers who sell Laser Products must maintain records of written communications between the manufacturer, dealers and customers concerning radiation safety. If you have any complaints about instructions or explanations affecting the use of this product, please feel free to write to the address on the back page of this manual. When you write us, please include the model number and serial number of your unit.

In compliance with Federal Regulations, the certification, identification and the period of manufacture are indicated on the rear panel.

FCC INFORMATION FOR USER

CAUTION:

The user changes or modifications not expressly approved by the party responsible for compliance could void the user's authority to operate the equipment.

NOTE:

This equipment has been tested and found to comply with the limits for a Class B digital device, pursuant to Part 15 of the FCC Rules. These limits are designed to provide reasonable protection against harmful interference in a residential installation. This equipment generates, uses and can radiate radio frequency energy and, if not installed and used in accordance with the instructions, may cause harmful interference to radio communications. However, there is no guarantee that interference will not occur in a particular installation. If this equipment does cause harmful interference to radio or television reception, which can be determined by turning the equipment off and on, the user is encouraged to try to correct the interference by one or more of the following measures:

- Reorient or relocate the receiving antenna.
- Increase the separation between the equipment and receiver.
- Connect the equipment into an outlet on a circuit different from that to which the receiver is connected.
- Consult the dealer or an experienced radio/TV technician for help.

Precautions

For Canadian model

NOTE:

THIS CLASS B DIGITAL APPARATUS COMPLIES WITH CANADIAN ICES-003.

For models having a power cord with a polarized plug:

CAUTION: TO PREVENT ELECTRIC SHOCK, MATCH WIDE BLADE OF PLUG TO WIDE SLOT, FULLY INSERT.

Modele pour les Canadien

REMARQUE:

CET APPAREIL NUMÉRIQUE DE LA CLASSE B EST CONFORME À LA NORME NMB-003 DU CANADA. Sur les modèles dont la fiche est polarisée:

ATTENTION: POUR ÉVITER LES CHOCS ÉLECTRIQUES, INTRODUIRE LA LAME LA PLUS LARGE DE LA FICHE DANS LA BORNE CORRESPONDANTE DE LA PRISE ET POUSSER JUSQU'AU FOND.

For British model

Replacement and mounting of an AC plug on the power supply cord of this unit should be performed only by qualified service personnel.

IMPORTANT

The wires in the mains lead are coloured in accordance with the following code:

Blue : Neutral
Brown : Live

As the colours of the wires in the mains lead of this apparatus may not correspond with the coloured markings identifying the terminals in your plug, proceed as follows:

The wire which is coloured blue must be connected to the terminal which is marked with the letter N or coloured black.

The wire which is coloured brown must be connected to the terminal which is marked with the letter L or coloured red.

IMPORTANT

A 5 ampere fuse is fitted in this plug. Should the fuse need to be replaced, please ensure that the replacement fuse has a rating of 5 amperes and that it is approved by ASTA or BSI to BS1362. Check for the ASTA mark or the BSI mark on the body of the fuse.

IF THE FITTED MOULDED PLUG IS UNSUITABLE FOR THE SOCKET OUTLET IN YOUR HOME, THEN THE FUSE SHOULD BE REMOVED AND THE PLUG CUT OFF AND DISPOSED OF SAFELY. THERE IS A DANGER OF SEVERE ELECTRICAL SHOCK IF THE CUT OFF PLUG IS INSERTED INTO ANY 13 AMPERE SOCKET.

If in any doubt, please consult a qualified electrician.

Declaration of Conformity

We, ONKYO EUROPE
ELECTRONICS GmbH
INDUSTRIESTRASSE 20
82110 GERMERING,
GERMANY



declare in own responsibility, that the ONKYO product described in this instruction manual is in compliance with the corresponding technical standards such as EN60065, EN55013, EN55020 and EN61000-3-2, -3-3.

GERMERING, GERMANY

I. MORI

ONKYO EUROPE ELECTRONICS GmbH

Table of contents

Connections

Connecting to Onkyo Separate Collection series components	8
Connecting to the other components	10

Operations

Playing CDs	13
-------------------	----

Other Information

Handling CDs	19
Troubleshooting	20
Indexed to parts and controls	21
Specifications	23

Supplied accessories

Check that the following accessories are supplied with this unit.



RI remote control cable × 1

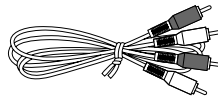

Audio connection cable × 1

Instruction Manual (This Manual × 1)

Connecting to Onkyo Separate Collection series components

This section introduces you to the other Separate Collection Series system components and their convenient system functions, followed by instruction on how to connect the system.

The following Separate Collection Series components are available:

- MD-101A Minidisc (MD) Recorder (Not available in U.S. and Canada)
- R-801A FM Stereo/AM Tuner Amplifier
- CDR-201A Audio CD recorder

Note that the available components may vary according to the area.

Combining the C-701A Compact Disc player with the above system components enables you to operate the following convenient functions:

- **Auto Power On**

- You can turn on the power to the amplifier by pressing the STANDBY/ON button on one of the system components. You can also turn off the power to only the C-701A by pressing this button.

Notes:

- If “DVD” has been selected as an input source for a connected R-801A, you need to change the input source to “CD” to operate the CD player in the system. (Refer to the R-801A instruction manual for more information.)

- **Direct Change**

Press the following button on the component you want to operate. The amplifier will automatically select the input from the corresponding component:

- The play button on the CD player, MD recorder, or stereo cassette tape deck.

- **Remote Control Operation**

You can operate all the system components using the remote controller supplied with the amplifier R-801A.

- **Program Timer**

You can operate the timer playback and recording functions using the R-801A. (Refer to the R-801A instruction manual for more information.)

- **Sleep Timer**

You can fall asleep to a music/radio program using the timer. (Refer to the R-801A instruction manual for more information.)

- **CD Dubbing**

Simple CD dubbing using an MD recorder or CD recorder is possible with the pressing of a single button. (Refer to the MD-101A or CDR-201A Instruction Manual for more information).

- **CD/MD/CDR Synchro Recording**

When using an MD recorder or CD recorder to record from the CD player, you can record with simply starting on a CD player. (Refer to the MD-101A or CDR-201A instruction manual for more information.)

- **Dubbing a specific track from CD**

You can specify a track on a CD and easily dub it to a connected MD recorder or CD recorder. (Refer to the MD-101A or CDR-201A instruction manual for more information.)

Using the remote controller

The unit is not shipped with a remote controller. However, you can use a remote controller (RC-466S) that is shipped with the R-801A.

Remote controller RC-466S

When the remote controller RC-466S supplied with the R-801A is used, operate the remote controller pointing towards the R-801A's remote sensor.

Be sure to make the **RI** connection securely. If the connection is incomplete, you cannot use the remote controller to operate the unit.

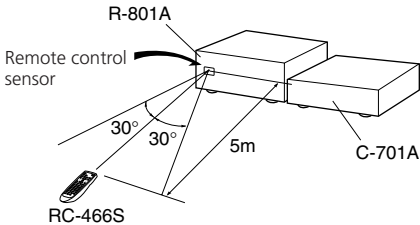

Notes

- Place the unit away from strong light such as direct sunlight or inverted fluorescent light which can prevent proper operation of the remote controller.
- Using another remote controller of the same type in the same room or using the unit near equipment which uses infrared rays may cause operational interference.
- Do not put any object such as a book on the remote controller. The buttons of the remote controller may be pressed by mistake and drain the batteries.
- Make sure the audio rack doors do not have colored glass. Placing the unit behind such doors may prevent proper remote controller operation.
- If there is any obstacle between the remote controller and the remote control sensor, the remote controller will not operate.

Connecting to the other components

Before connecting

- Do not connect the unit's AC power cord to a wall outlet until you have completed all the other connections.
- On each pair of connectors, a red connector (marked R) corresponds to the right channel, and a white connector (marked L) to the left channel. Connect white plugs of audio connection cables to L connectors and connect red plugs of audio connection cables to R connectors.

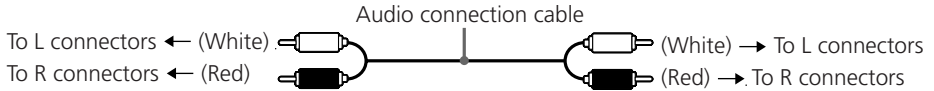

- Insert the plug securely. If the connection is incomplete, noise or malfunction may result.

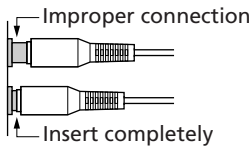

- When you use a digital audio optical cable, do not bend it sharply nor coil it tightly.
- Bundling an audio connection cable with the power cord or speaker cord may degrade the sound quality.
- To use the unit with the other Onkyo Separate Collection series components, follow the connection diagram in the R-801A instruction manual to connect the unit to the system.

Note:

The 230-240 V model is shown in the following illustrations.

Connections

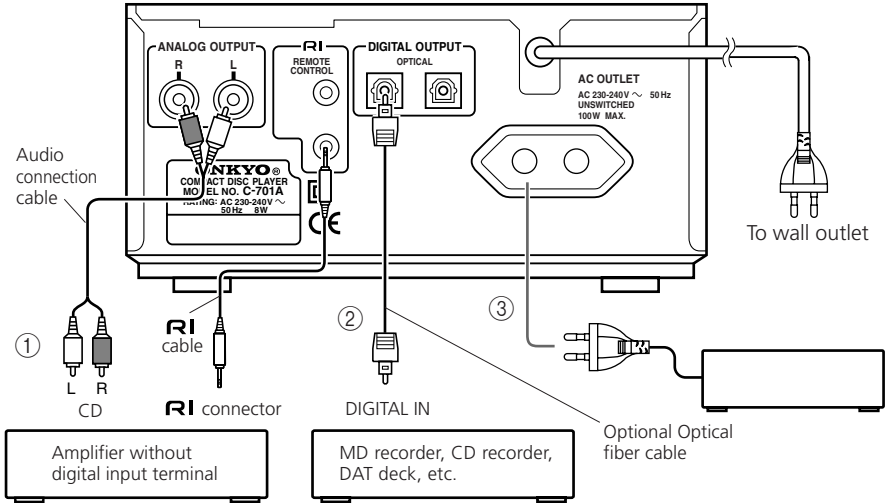

① Connection with the Amplifier

Connect the ANALOG OUTPUT connectors on the rear panel of C-701A and the amplifier's CD input connectors using the audio connection cable. Refer to the amplifier's instruction manual for connections.

② Connection to DIGITAL OUTPUT connector

Using the DIGITAL OUTPUT connector, you can record on digital audio equipment, such as an MD, CD-R, DAT, etc. For digital recording, connect the equipment to either DIGITAL OUTPUT OPTICAL connector using the optical cable (option). These connectors can also be used for connecting an amplifier which is equipped with a digital input connector.

A connector protection cap is attached to the digital output connector. Remove this cap to connect the unit to other digital equipment. When you are not using the digital output connector, replace this cap.

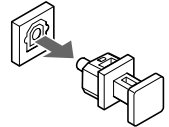

③ AC OUTLET (UNSWITCHED)

The AC power cord of another component can be connected to this AC OUTLET connector.

This means that if the C-701A is plugged into an AC outlet, AC power is available to this AC OUTLET even if the C-701A is off.

The shape and capacity of the AC outlet may differ depending on the area of purchase. Make sure that the capacity of other components connected to this unit does not exceed the capacity that is printed on the rear panel.

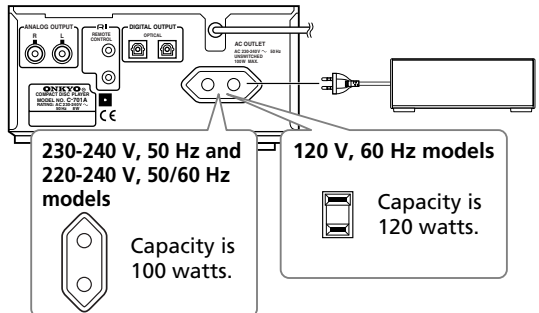

Connecting to the other components

Connecting the RI connector

If you are using other ONKYO components equipped with **RI** connectors, you can control these components using the amplifier's remote controller.

Before connecting

- The amplifier must be connected in the **RI** system hookups for **RI** control operations.
- Each component has two **RI** connectors. There is no difference between those connectors.
- The components may be connected in any order.
- Remote control operation is not possible if only the **RI** remote control cable is connected to the **RI** connectors. Connect the audio connection cables correctly.

The illustration below is the **RI** hookup example. With these hookups, you can operate the CD Synchro Recording (see "CD/MD/CDR synchro recording" on page 8).

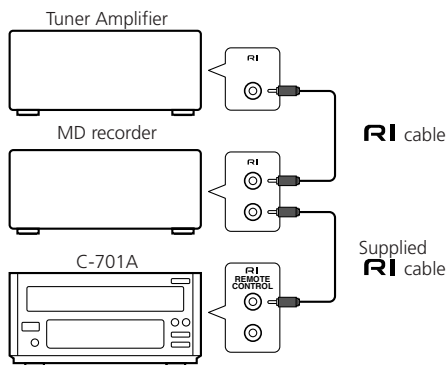

Note

An **RI** remote control cable equipped with a 1/8 in. (3.5mm) diameter miniature two-conductor phone plug is included with this unit and with every tuner and cassette deck that bears the **RI** mark.

Connecting the power cord

Insert the AC power cord into a wall outlet. The **STANDBY** indicator lights.

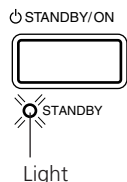
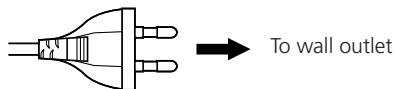

- To use the unit with the other Onkyo Separate Collection series components, follow the connection diagram in the R-801A instruction manual to connect the unit to the system.
- If you press the ▲ (OPEN/CLOSE) button while the unit is in the **STANDBY** mode, the power will turn on and the display will light up automatically.

Operations

Playing CDs

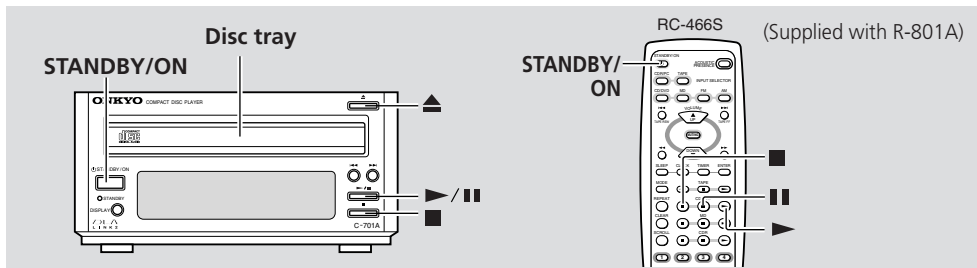

Normal play

1 Press **STANDBY/ON** button to turn on the unit.

The STANDBY indicator goes off, and the display will light up.



2 Press the **▲ (OPEN/CLOSE)** button to open the disc tray.

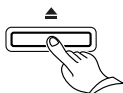

3 Put the disc in the disc tray, with its label side facing up.

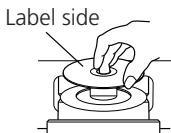

4 Press the **▲** button to close the disc tray.

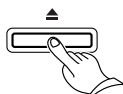

Note

You can skip this step by pressing the **▶/||** button instead of the **▲** button. In this case, the disc tray closes automatically and Track 1 starts playing.

5 Press the **▶/||** button.

The CD player starts playing the first track (track 1).

Remote controller



- If the **▶/||** button is pressed when the unit is in STANDBY mode, it turns on automatically then starts playing the CD, if it is loaded in the disc tray. Your tuner amplifier also turns on if it is an Onkyo R-801A (refer to page 8).

If the CD player does not start playing when the **▶/||** button is pressed

- The disc may be upside down in the tray. Press the **▲** button to open the disc tray. If you cannot see the label on the disc, turn the disc over, label side up.
- Moisture may have formed inside the CD player. Remove the CD from the disc tray and leave the power on for about one hour to evaporate the moisture.

To stop playing

Press the **■** button.

Remote controller



To pause playing

Press the **▶/||** button or the **||** or **▶** button on the remote controller. (The PAUSE indicator lights.) To resume play, press the **▶/||** button.

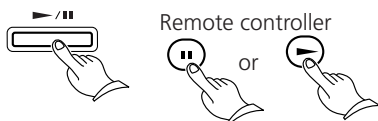

Playing CDs

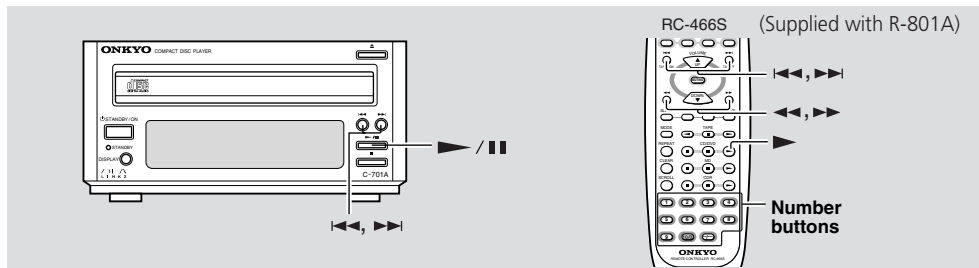

Starting playback from a given track

- 1 Select the track you wish to play using the **◀◀** and **▶▶** buttons (or the **◀◀** and **▶▶** buttons on the remote controller).

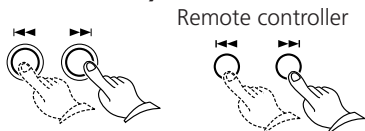

Search play

- 1 Hold down the **◀◀** or **▶▶** button (or the **◀◀** and **▶▶** buttons on the remote controller) during play.

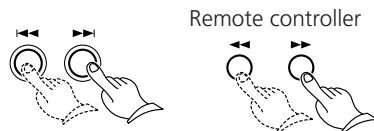

- 2 Press the **▶ / ||** button.

The CD player starts playing the selected track.

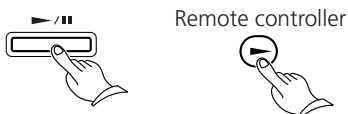

- 2 Release your finger when the music you would like to listen to is reached.

The music starts playing from that point.

Using the remote controller

With the RC-466S remote controller (supplied with the R-801A), you can select the track to play using the number buttons. In either case, selecting a track automatically starts play of that track.

How to enter track numbers

To enter track #5 : **5**

To enter track #10 : **10/0**

To enter track #21 : **--/--** → **2** → **1**

Skip play

Each time the **▶▶** button (or the **▶▶** button on the remote controller) is pressed when a disc is playing, the pickup will advance one track; and each time the **◀◀** button (or the **◀◀** button on the remote controller) is pressed when a disc is playing, the pickup will go back one track. Press these buttons until the desired track number is selected.

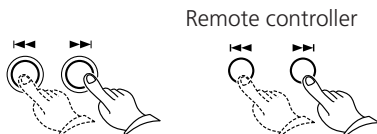

Display information

When you press the **DISPLAY** button while the unit is stopped, the following indication appears.

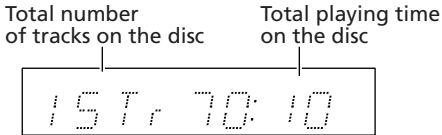

Checking the playing time of each track

You can view the playing time of each song on the disc by pressing the **◀◀** or **▶▶** button repeatedly while the unit is stopped.

For Track 21 or later tracks, the display shows "--:--" (or "--:--").

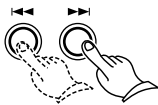

Checking the elapsed or remaining time

The display changes each time you press the **DISPLAY** button during play.

Ⓐ Shows how long the current track has been playing.

Ⓑ Shows how much time is left for the track currently playing.

For Track 21 or later tracks, the display shows "--:--" (or "--:--").

Ⓒ Shows how much playing time is left for the entire disc.

During Memory play, this display shows the playing time remaining for the entire sequence of tracks programmed into memory.

For Track 21 or later tracks, the display shows "--:--" (or "--:--").

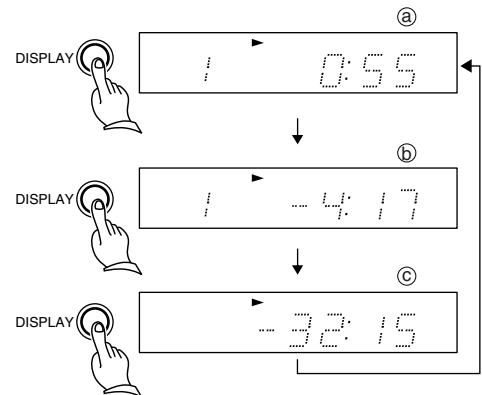

Notes on the CD player time display

In the following cases, the time display may indicate "--:--" (in rare cases "--:--:--" is displayed) due to the memory limitations.

- If you switch to the remaining time display while the CD player is playing the 21st or later song on the disc
- If you switch to the total remaining time display after storing the 21st or later song on the disc
- If you switch to the total remaining time display after the CD player plays songs from memory for more than 99 minutes 59 seconds, or
- If you switch to the total remaining time display during random playback of a CD that contains 21 or more songs.

Playing CDs

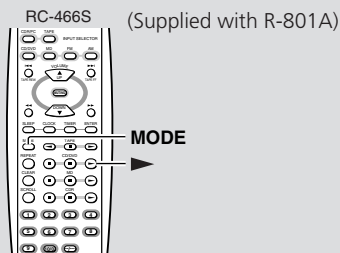

- To perform Random, Memory or Repeat play, you need the following remote controller:
RC-466S (supplied with R-801A)

Playing tracks in random order (Random play)

- 1 Press the MODE button repeatedly while the unit is stopped to turn on the RDM indicator.**

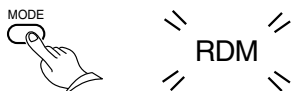

- 2 Press the ► button.**



The CD player plays the tracks in a random order.

To quit Random play

- Press the MODE button on the remote controller repeatedly to turn off the RDM indicator.
- Playback is cancelled when you press the ▲ (OPEN/CLOSE) button to open the tray.

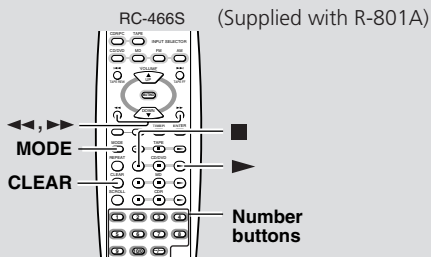

Memory play

- Up to 25 tracks can be stored in memory.

1 Press the MODE button repeatedly while the unit is stopped to turn on the MEM indicator.

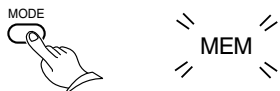

2 Press the number button(s) to select your desired track.

To enter further track numbers into memory, repeat this step.

3 Press the ► button.

The track in memory are played in the order you specified.



Note

- If more than 25 tracks are already in memory, "FULL" will light on the time display to indicate that the memory is full.
- If the MEMORY button is pressed during play, the currently playing track is stored into memory.

To stop Memory play

Press the ■ button.



How to enter track numbers

To enter track #5 : (5)

To enter track #10 : (10/0)

To enter track #21 : (←/→) → (2) → (1)

To view program information

After Memory play is finished, press the ◀◀ or ▶▶ button repeatedly (while the unit is stopped) to display the track numbers in the programmed order.

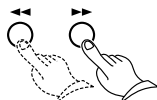

To clear the last track stored

Press the CLEAR button while the unit is stopped. The last track you stored into memory is cleared.



To quit Memory play

Press the MODE button repeatedly while the unit is stopped to turn off the MEM indicator, or just press ▲.

The contents of the memory are completely cleared.



Playing CDs

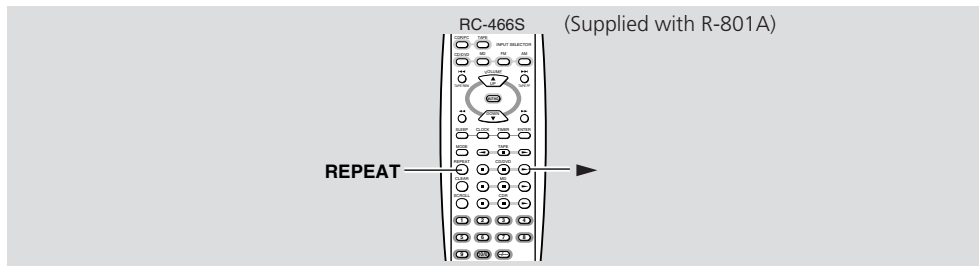

Playing all tracks on disc (Repeat play)

1 Press the REPEAT button while the unit is stopped to enter Repeat play mode.

The REPEAT indicator lights.

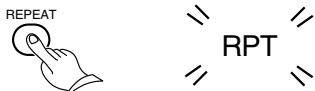

To quit Repeat play

Press the REPEAT or  button. The REPEAT indicator disappears to indicate that you are in Normal play mode.

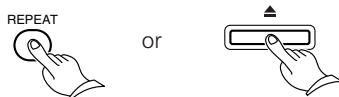

2 Press the button to start Repeat play.



- When the last track is completed, the CD player returns to the beginning of the disc and plays all the tracks on the disc again.
- Repeat play can be performed in conjunction with Normal, Memory and Random play modes. The REPEAT button can be pressed even when a track is playing.

Play mode	Repeated tracks
Normal	All tracks on disc
Memory	Tracks in memory (in stored order)
Random	Repeats random play of all tracks on disc.

Other Information

Handling CDs

Playable discs

This unit can play back the following discs.

	Disc mark	Contents	Disc size
Audio CDs		Audio	12 cm
			8 cm (CD single)

You cannot play back discs other than those listed above.

Do not play CD-ROMs intened for computer use or non-audio compact discs. Doing so may cause high-pitched noises or other unpredictable results that may damage speakers, amplifiers, and other connected components.

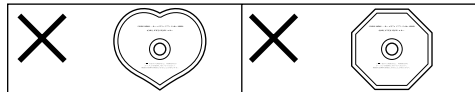

Avoid using heart-shaped or octagonal discs. Playing irregularly shaped discs may damage the internal mechanism of the unit.

Do not use discs on which adhesive from adhesive tape or a disc label (if it is a rental disc) remains. Otherwise, you may not be able to eject the discs or the unit may become inoperative.

Taking the CD out of the disc case

1 Hold the disc case in the palm of one hand and pull the cover upward with the other hand to open the disc case.

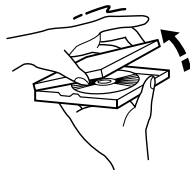

2 While pushing on the center grip of the disc case with your finger, take out the disc by holding its edges.



Important notes on handling CDs

- Carefully lift the disc from the disc case, making sure to only hold the disc by its edges or the hole in the middle.



- A dry, soft cloth may be used to wipe dust and fingerprints off the surface of CDs.



- Do not use volatile agents on discs, such as thinner or benzine. Also, do not use conventional record cleaner or antistatic agents.
- Do not place a CD in direct sunlight or locations subject to high humidity or low temperature.
- Do not store a CD in the CD player tray for long periods of time.

Excessive electrical interference may temporarily render this system's sensitive microcomputer inoperable. If this happens, unplug the system for at least five seconds.

Troubleshooting

If you have any problems with the unit, please check the troubleshooting table below first. For any problems not covered in the table, please consult your nearest Onkyo authorized service center.

Symptom	Cause	Remedy
STANDBY/ON button is pressed, but power does not come on.	<ul style="list-style-type: none"> Power cord plug is not properly connected to AC outlet. 	<ul style="list-style-type: none"> Insert the plug firmly.
Disc is loaded in the disc tray, but playback will not begin.	<ul style="list-style-type: none"> Disc is in the disc tray upside down. Disc is dirty. Moisture has accumulated inside the CD player. You are playing an incorrectly-recorded CD-R. 	<ul style="list-style-type: none"> Load the disc with the label facing upward. Clean the disc. Remove the disc from the disc tray, place the CD player in a warm place and leave the power on for about one hour. Replace the disc.
No sound	<ul style="list-style-type: none"> Incomplete or incorrect connections. Improper input selector switch setting on amplifier. 	<ul style="list-style-type: none"> Check all cable connections. (See pages 10-12) Insert all plugs firmly into jacks. Set switch to proper position. See your amplifiers operating instructions for more information.
Disc skipping	<ul style="list-style-type: none"> Disc is dirty. Disc is scratched. CD player has been bumped. 	<ul style="list-style-type: none"> Clean the disc. (See page 19) Replace the disc. Place the CD player in a more stable location.
Search time (when moving to a specific track) is extremely long.	<ul style="list-style-type: none"> Disc is dirty. Disc is scratched. 	<ul style="list-style-type: none"> Clean the disc. (See page 19) Replace the disc.
Track numbers cannot be stored in the memory.	<ul style="list-style-type: none"> No disc in the tray. A track number not on the disc is being input. 	<ul style="list-style-type: none"> Load a disc into the tray. Use only the track numbers on the disc.
Noise during play	<ul style="list-style-type: none"> Interference from TV 	<ul style="list-style-type: none"> Turn off the TV, or move the unit farther from the TV.
Remote controller does not function.	<ul style="list-style-type: none"> Battery level is low. Your position is too far from the unit's remote control sensor or out of the sensor's detection angle. An obstacle exists between you and the unit's remote control sensor. The system components are not connected properly. "DVD" has been selected as the input source for R-801A. 	<ul style="list-style-type: none"> Replace the batteries. Remote controller is possible within a distance of approximately 5 meters from the unit's sensor and a detection range of 30°. Operate from a different position or remove the obstacle. Connect the system components properly according to the R-801A instruction manual. Select "CD" as the input source. (Refer to the instruction manual for the R-801A.)

Indexed to parts and controls

For operational instructions, refer to the page indicated in parentheses.

Front panel

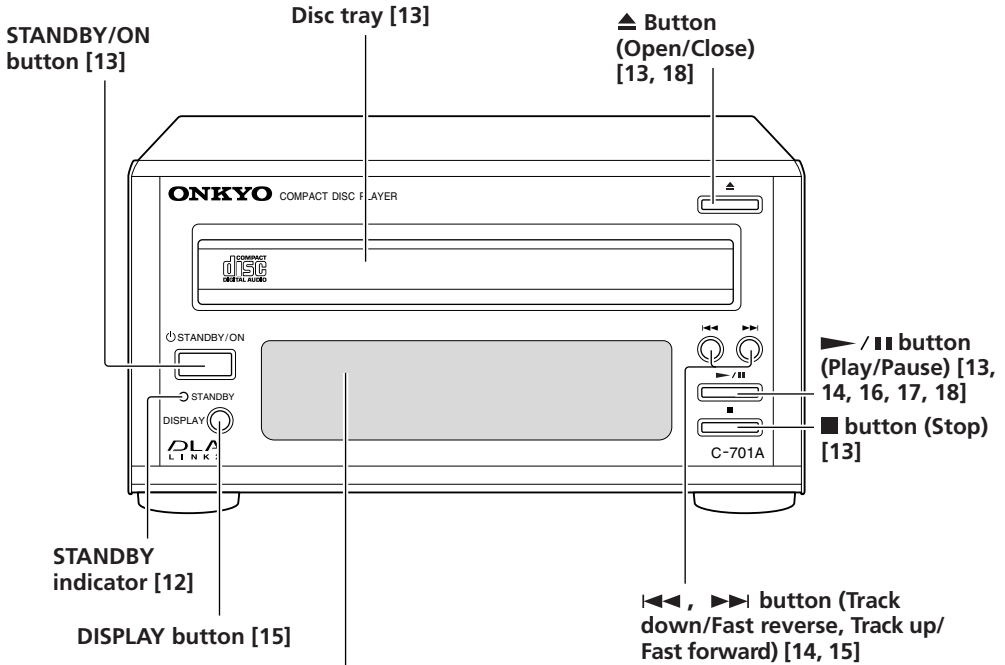

Display

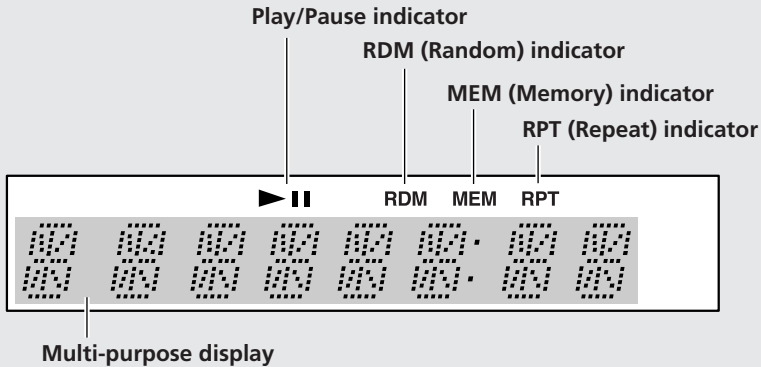

Remote controller

Remote controller supplied with the R-801A (RC-466S)

To operate the supplied remote controller, make the appropriate connection to the **RI** remote connectors.

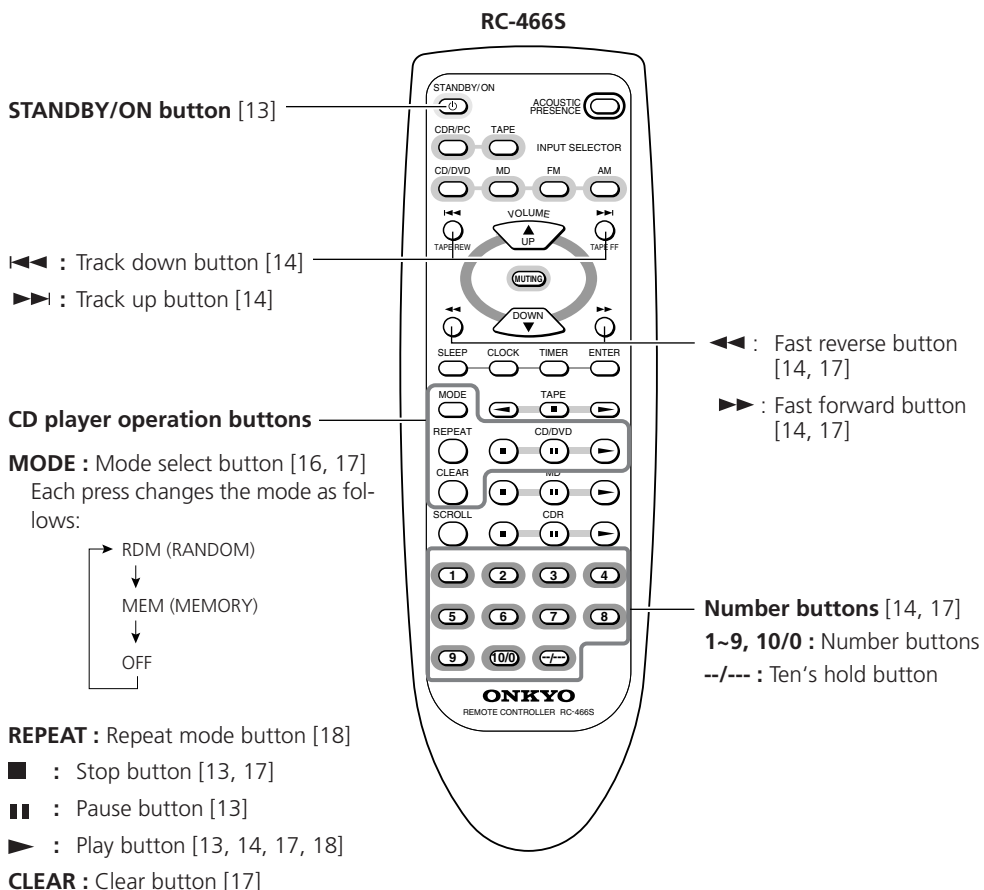

REPEAT : Repeat mode button [18]

■ : Stop button [13, 17]

⏸ : Pause button [13]

▶ : Play button [13, 14, 17, 18]

CLEAR : Clear button [17]

Specifications

Signal readout system : Optical non-contact

Reading rotation : About 500 – 200 r.p.m.
(constant linear velocity)

Linear velocity : 1.2 – 1.4 m/s

Error correction system :
Cross Interleave Reed Solomon code

D/A converter : 1 bit D/A converter

Sampling frequency : 352.8 kHz
(Eight-times oversampling)

Number of channels : 2 (stereo)

Frequency response : 5 Hz – 20 kHz

Total harmonic distortion : 0.009% (at 1 kHz)

Dynamic range : 92 dB

Signal to noise ratio : 80 dB

Channel separation : 80 dB (at 1 kHz)

Wow and Flutter :

Below threshold of measurability

Output level : 2 volts r.m.s.

Power consumption :

AC 230-240 V, 50 Hz model : 8 watts

AC 220-230V, 50Hz/60Hz : 8 watts

AC 120 V, 60 Hz model : 9 watts

Power supply rating :

AC 230-240 V, 50 Hz

AC 220-230V, 50Hz/60Hz

AC 120 V, 60 Hz

Dimensions (W x H x D) :

155 x 76 x 283.5 mm (chinese models)

6-1/8" x 3" x 11-3/16"

155 x 76 x 281.5 mm (other models)

6-1/8" x 3" x 11-1/16"

Weight : 2.0 kg, 4.4 lbs.

Specifications and external appearance are subject to change without notice because of product improvements.

ONKYO CORPORATION

Sales & Product Planning Div. : 2-1, Nisshin-cho, Neyagawa-shi, OSAKA 572-8540, JAPAN
Tel: 072-831-8111 Fax: 072-833-5222

ONKYO U.S.A. CORPORATION

18 Park Way, Upper Saddle River, N.J. 07458, U.S.A.
Tel: 201-785-2600 Fax: 201-785-2650 <http://www.onkyousa.com>

ONKYO EUROPE ELECTRONICS GmbH

Industriestrasse 20, 82110 Germering, GERMANY
Tel: 089-849-320 Fax: 089-849-3265 E-mail: info@onkyo.de

ONKYO CHINA LIMITED

Units 2102-2107, Metroplaza Tower I, 223 Hing Fong Road, Kwai Chung,
N.T., HONG KONG Tel: 852-2429-3118 Fax: 852-2428-9039

